

MicroVibe P

CMVL 3850

Vibration Assessment That Fits in Your Pocket



With SKF's new MicroVibe P, vibration assessment is as close and convenient as your PDA! This economical vibration meter expansion module fits in a PocketPC's compact flash card slot (CF Type II) and features the user-friendly Windows Mobile Operating System. Identify problems and assess machine condition quickly and easily with this versatile and easy-to-use pocket tool.

POWER WITHOUT COMPLEXITY

A handy "quick-check" solution, based on the universal PDA platform, MicroVibe P is simple to use. Built-in automatic functions virtually eliminate set-up, while the analytical displays and automatic judgment of machine vibration readings help users identify machine problems on the spot!



The SKF MicroVibe P System.

- **Universal PDA platform with user-friendly Windows™ Mobile OS.**
- **Displays overall vibration, time-waveform, FFT spectrum analysis and early indication of bearing degradation.**
- **Easily operated by novice and experienced users.**
- **On-board vibration dictionary.**
- **Enables experienced Pocket PC users to upload overall scalar and spectral data to PC for trending and further analysis with included Data Management Software.**
- **Kit includes MicroVibe P Module, MicroVibe P Data Management Software, Accelerometer and Cable, Stinger and Magnet, Earphones and Carrying Case (does not include PDA).**

AN ADVANCED INSTRUMENT FOR SIMPLIFIED VIBRATION ASSESSMENT

The MicroVibe P collects and displays overall vibration readings and automatically provides expert judgment of the measured velocity and overall enveloped acceleration levels, enabling immediate, accurate and reliable assessment of machine or bearing condition.



MULTI-POINT AUTOMATION™ SAVES TIME AND IMPROVES RELIABILITY

Automatically collect the most useful measurements for vibration analysis – acceleration, velocity, displacement, and enveloped acceleration – simultaneously. SKF’s Multi-point automation™ saves time and enhances the power, accuracy and overall reliability of your decision making – giving you the information needed to make the best possible judgment call.

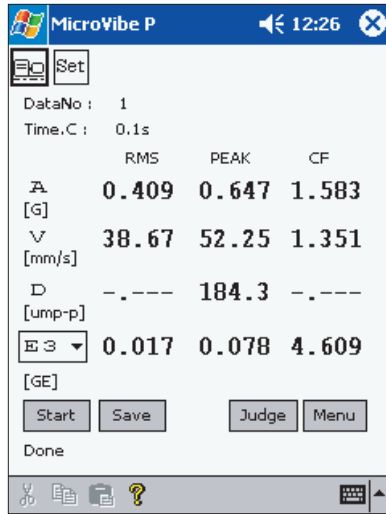

AUTOMATIC SETUP AND ONBOARD EXPERTISE

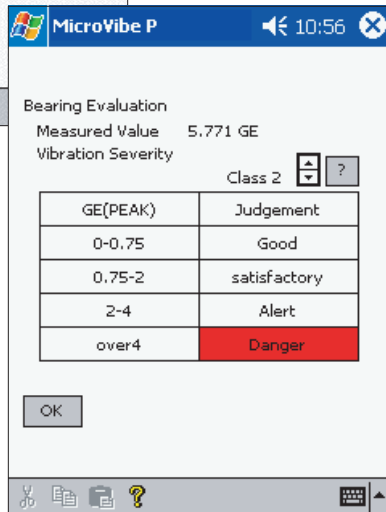
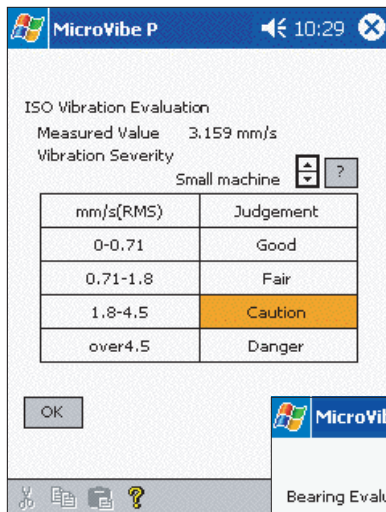

The MicroVibe P provides extensive automatic setup and evaluation of vibration results. Simply collect the data and MicroVibe P does the rest – comparing readings to pre-programmed Velocity and Enveloped Acceleration severity criteria for a reliable and accurate evaluation of vibration severity. This allows even novice users to easily determine abnormal conditions and take appropriate action.

FFT SPECTRUM ANALYSIS CAPABILITIES

With pre-set measurements and user selectable FFT resolution at 400, 800 or 1600-lines, selectable Fmax and a 90 db dynamic range, the MicroVibe P has what it takes to help you easily pinpoint the start of impending machine problems. Cursor position readout with display zoom optimizes your analysis power. In addition, it automatically tabulates and displays the highest vibration peaks from a spectrum, making it easy to quickly identify signals indicative of specific machine problems, like misalignment, imbalance or bearing faults.

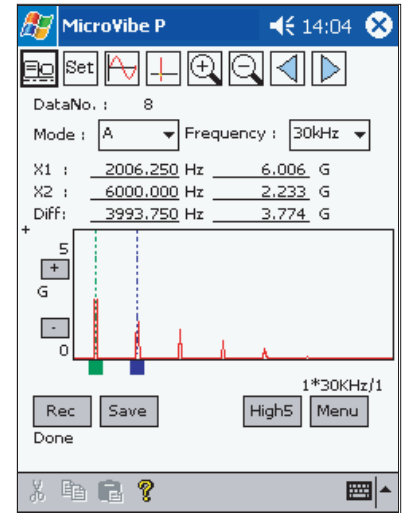

TIME-WAVEFORM DISPLAYS

Measure and store time data, with the capability to select acquisition type and time measurement. Time displays in acceleration, velocity, displacement or enveloped acceleration. A unique automatic transient capture function starts taking measurements when the signal exceeds a user-specified trigger level, enabling more detailed analysis of the pre- and post-trigger events surrounding a change in machine condition.

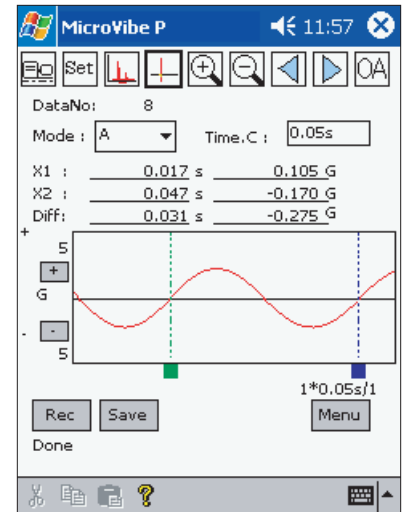

VERSATILE MEASUREMENT CAPABILITY

The MicroVibe P works with the two most commonly used vibration sensors – accelerometers and dynamic velocity transducers. Both enable you to take a multi-parameter approach to your analysis and to optimize vibration data gathering.

AUDIO ANALYSIS

Now you can actually listen to machine problems using the MicroVibe P’s acoustic capability. Simply



AUDIO ANALYSIS *(continued)*

connect the earphones and listen to the operation of your machine. When abnormal noise is detected, use the vibration analysis capabilities of the MicroVibe P Analyzer to zero in on the problem.

STORE AND RECALL MEASUREMENTS FOR TRENDING AND ANALYSIS

The MicroVibe P's data storage capacity is also extraordinarily impressive. It can store up to 2,000 overall vibration signals, 1,000 FFT spectrums or 200 records of time waveform data for later recall. A search function retrieves specific measurement points and a "repeat" measurement lets you recall and repeat any measurement for more focused analysis or trending of a potential problem. Finally, a "recall data storage" list helps you keep track of and reference all collected data.

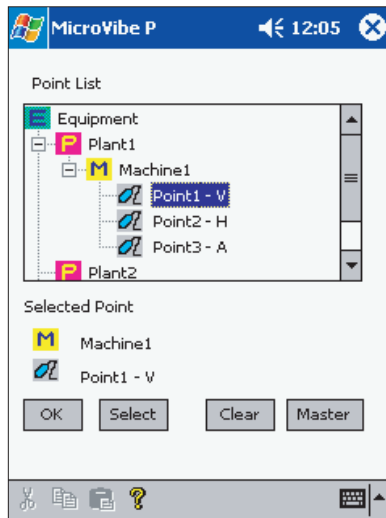

DATA MANAGEMENT AND SOFTWARE FOR DESKTOP COMPUTER

The next generation MicroVibe P now offers added functionality, including a software program to extract, save, edit and display collected data. It's even ideal for small route data collection.

For further analysis and trending, data may be uploaded to your desktop computer using the Data Management software. Once uploaded, vibration data, overall trends and spectra can be stored, trended and graphically displayed.

UTILITIES ADD VALUE

Several exciting utilities help make the MicroVibe P a universal tool for machine vibration analysis, for any level of expertise. Collect data in English or Metric units or reference a dictionary of vibration terminology. An internal signal generator is also included, so you can perform field calibration of systems and instruments conveniently and easily.

SKF's new MicroVibe P truly brings you vibration monitoring and analysis power without complexity. It's tomorrow's big solution for vibration analysis in a small, smart package – and its available today! Get more information at www.skf.com/reliability.

SKF Reliability Systems is part of the worldwide SKF Service organization. The organization's condition monitoring and service businesses extend machine service life, reduce overall maintenance costs and improve plant efficiency by creating integrated solutions for end-users who need to improve plant operation and reliability maintenance management with minimal investment.

SPECIFICATIONS

MicroVibe P CMVL 3850

Minimum PDA Requirements:

Conforms to the Pocket PC Specifications

Operating System: Microsoft Pocket PC 2003 (Windows Mobile 3.0)

Processor: ARM Processor

Interface: Compact Flash TYPE II Slot 3.3 V only

Recommended Specifications:

Processor: PXA255 400 MHz or higher

Memory (RAM): 64 MB or higher

Interface with Pocket PC: Compact Flash TYPE II, Slot 3.3 V only

Power Supply: +3.3 V (Supplied by Pocket PC)

Current:

Standby: 44 μ A

Under Measurement: 48 mA

Pickup Input (PU IN):

AC Voltage Signal: Maximum +/- 2.5 V

Input Terminal: 8-pin modular jack (RJ-45) (ICP type pre-amp built-in accelerometer is not connected).

Raw Waveform Output (PU OUT):

AC Voltage Signal: Maximum +/- 2.5 V

Output Terminal: Mini-jack (2.5 mm ϕ)

Sampling Frequency: Maximum 76.8 kHz (Changes according to Mode) 76.8 kHz/38.4 kHz

Aliasing Filter: 20 kHz/2 kHz (Changes according to Mode and Sampling Frequency)

A/D: 16-Bit

Temperature Range: 0 to +45°C (+32°F to +113°F)

Humidity Range: <90% relative humidity, non-condensing

Weight: 25 g (0.88 oz) approximate (Card only)

Dimensions: 60.0 mm x 42.1 mm x 16.9 mm (2.36" x 1.66" x 0.67")

Shape: Conforms to CF Card TYPE II, Card Type. See photograph.

Color: Black

CMSS 3811 Accelerometer

Type: Pre-amp is built-in. Shear type.

Power Supply: DC +/- 5 V

Voltage Sensitivity: 20 mV/g

Resonance Frequency: 20 kHz approximate

Frequency Range: 3 Hz to 10,000 Hz

Maximum Acceleration: 500 m/s²

Vibration Limit: 5000 m/s²

Maximum Output Voltage: +/- 1 V

Output Impedance: Below 100 Ω

Temperature Range: -20°C to +80°C (-4°F to +176°F)

Material: SUS

Weight: 60 g (2.1 oz) approximate

Tapped Hole: M6, P = 1, depth 5 mm, internal thread

Integral Cable: Length 1.5 meters (5 feet)

Connector: 8-pin modular plug

Dimensions: See Drawing Below

Structure: Dust-proof, spray-proof

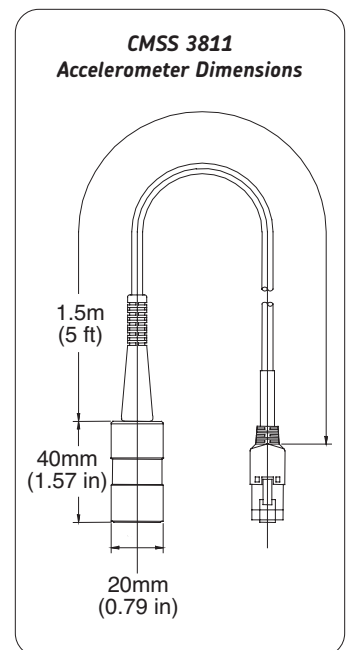

MicroVibe P CMVL 3850

MEASUREMENT SPECIFICATIONS

(For Measurement with CMSS 3811 Accelerometer)

Frequency Specifications

Item	Specifications
Frequency Range	
A	Acceleration: 10~15 kHz (*1)
V	Velocity: 10~1000 Hz
D	Displacement: 10~150 Hz
E1	Envelope Detection: 5~100 Hz
E2	Envelope Detection: 50~1 kHz
E3	Envelope Detection: 500~10 kHz
E4	Envelope Detection: 5 k~20 kHz
Sampling Frequency	A, E3, E4: 76.8 kHz E1, E2, V, D: 38.4 kHz
Aliasing Filter	A, E3, E4: 20 kHz E1, E2, V, D: 2 kHz
Range	
A, E1, E2, E3, E4	0~1G: (x100 range) 0~5G: (x20 range) 0~20G: (x5 range) 0~100G: (x1 range)
V	0~10 mm/s: (x100 range) 0~50 mm/s: (x20 range) 0~200 mm/s: (x5 range) 0~1000 mm/s: (x1 range)
D	0~50 m: (x100 range) 0~250 m: (x20 range) 0~1000 m: (x5 range) 0~5000 m: (x1 range)

(*1) The upper bound frequency can be changed by Utility Menu's A Filter.

Overall and Judgment Specifications

Item	Specifications
Overall Value Simultaneous Measurement	Simultaneous Measurement of Overall Vibration Level, Multi-Mode (A, V, D, E1~E4) Range = Auto Measuring Time = 0.1s; 0.5s; 1.0s Measurement Data = RMS Value, PEAK Value, C.F. Value Measured Value Display Digits: Significant Figure 4 digits Example: .9999/ 999.9/ 99.99/ 9.999 Status Display (Under Measurement, Measurement End)
Judgment	Abnormal Judgment by Vibration Severity Standard (ISO-10816 [JIS-B-0906] Standard) Abnormal Bearing Judgment by Enveloped Acceleration E3 Mode

Display Specifications

Item	Specifications
Graph Display	FFT Graph <ul style="list-style-type: none"> • Dominant Frequency Component (Highest 5 Frequencies) • Cursor Indication Value Display • Zoom Scroll Value Display Waveform Graph <ul style="list-style-type: none"> • Cursor Indication Display • Zoom Scroll Display



FFT Specifications

Item	Specifications
FFT, Waveform Analysis	<p>Mode = A/ V/ D/ E1/ E2/ E3/ E4 Range = Fixed/ Auto FFT Measurement Condition Analysis Frequencies: Selection List • A: 250/ 500/ 1k/ 2k/ 5k/ 10k/ 15k/ 30k Hz • V: 250/ 500/ 1k Hz • D: 250/ 500 Hz • E1: 50 Hz • E2: 250/ 500 Hz • E3: 250/ 500/ 1k/ 2k/ 5k Hz • E4: 250/ 500/ 1k/ 2k/ 5k/ 10k Hz Lines of Resolution: 1600/ 800/ 400 Averaging: Stable/ Exponential/ Peak Hold 1/ 2/ 4/ 8 Times Window: Hanning/ Rectangular/ Flat Top</p> <p>Measurement Mode: Normal/ Recorder/ Post Process • Normal: Recording time of waveform data is determined by FFT measurement condition (analysis frequency, line number). Executes the measurement for average cycle in FFT and records the waveform for frame time (final frame time). • Recorder: Records the waveform of specified time by Rec.time. Average cycle of FFT is one time. • Rec. Time: 1/ 2/ 5/ 10 sec • Post-Process: Calculates from raw waveform data (temporary saved data). Average cycle of FFT is one time.</p> <p>Trigger Function Trigger: Input Signal Trigger Trigger Level : 0/ 10/ 20/ 30/ 40/ 50/ 60/ 70/ 80/ 90%. Specify % of the used range Delay: 0/ 10/ 20/ 30/ 40/ 50%. Specify % of the specified waveform measurement time</p> <p>Status Display: During measurement, Measurement end</p>

ORDERING INFORMATION

MicroVibe P Kit CMVL 3850

Includes:

- Data Management Software CD-ROM, One (1) Each.
- CMSS 3811 Accelerometer, 1.5 Meters (5 Feet) Integral Cable, Plug and Stinger One (1) Each.
- CMAC 3825 Two-Bar Magnetic Base, High Strength 40 lb Pull, One (1) Each.
- CMAC 3830 Earphones, One (1) Each.

NOTE: Pocket PC NOT INCLUDED.

Recommended Pocket PC's

- HP IPAQ Pocket PC 2003 h2215
- Toshiba Pocket PC 2003 e800

ACCESSORY OPTIONS

- CMSS 3811 Accelerometer, 1.5 Meters (5 Feet) Integral Cable (Replacement), Plug and Stinger, One (1) Each.
- CMSS 3812 Velocity Pickup Sensor, 1.5 Meters (5 Feet) Integral Cable, with Plug, One (1) Each.
- CMAC 3825 Two-Bar Magnetic Base, High Strength 40 lb Pull, One (1) Each.
- CMAC 3830 Earphones, One (1) Each.

SKF Reliability Systems

5271 Viewridge Court
 San Diego, California 92123 USA
 Telephone: (+1) 858-496-3400
 FAX: (+1) 858-496-3531

Web Site: www.skf.com/reliability

Although care has been taken to assure the accuracy of the data compiled in this publication, SKF does not assume any liability for errors or omissions. SKF reserves the right to alter any part of this publication without prior notice.

- SKF is a registered trademark of SKF.
- All other trademarks are the property of their respective owners.

CM2285 (Revised •-04)
 Copyright © 2004 by SKF Reliability Systems.
 ALL RIGHTS RESERVED.

